

Proportional reducing valves

digital, pilot operated, open loop, subplate or modular mounting

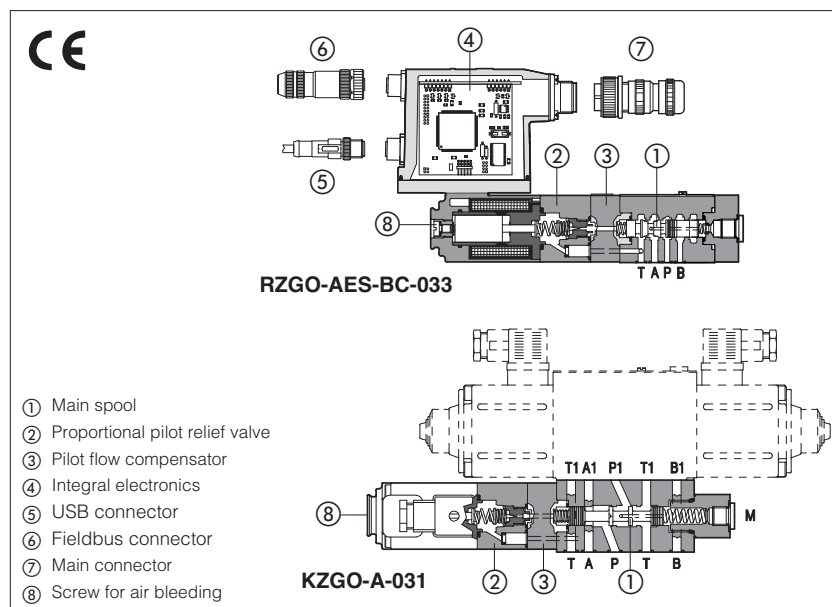

- ① Main spool
- ② Proportional pilot relief valve
- ③ Pilot flow compensator
- ④ Integral electronics
- ⑤ USB connector
- ⑥ Fieldbus connector
- ⑦ Main connector
- ⑧ Screw for air bleeding

RZGO-A, RZGO-AEB, RZGO-AES HZGO-A, KZGO-A

Spool type pilot operated digital proportional reducing valves for pressure open loop controls, available in subplate size 06 or modular mounting size 06 and 10 Executions:

- **A** without integral driver, to be coupled with separated driver, see section 2
- **AEB**, only for **RZGO**, with basic integral digital electronic driver, analog reference signals and USB port for software functional parameters setting
- **AES**, only for **RZGO**, with full integral digital electronic driver and fieldbus interface for functional parameters setting, reference signals and real-time diagnostics

The integral digital electronic driver performs the valve's hydraulic regulation according to the reference signal and assures valve-to-valve interchangeability thanks to the factory presetting

Size: **06** and **10**
Max flow: **40** and **100 l/min**
Max pressure: **350 bar**

1 MODEL CODE

RZGO	-	A	-	EB	-	NP	-	033	/	210	/	*	/	**	/	*
<p>Proportional pressure reducing valves</p> <p>RZGO subplate, size 06 HZGO modular, size 06 KZGO modular, size 10</p> <p>A = open loop pressure control</p> <p>- = omit for execution with separated driver see section 2</p> <p>only for RZGO: EB = basic integral driver ES = full integral driver</p> <p>Fieldbus interfaces - USB port always present (1): NP = Not present BP = PROFIBUS DP BC = CANopen EH = EtherCAT</p> <p>Configuration: 031 = regulation on port P1, discharge in T (only for HZGO, KZGO) 033 = regulation on port A, discharge in T (only for RZGO)</p>																
<p>Seals material, see sect. 5, 6: - = NBR PE = FKM BT = HNBR</p> <p>Series number</p>																
<p>Coil voltage only for -A - see section 8: - = standard coil for 24V_{DC} Atos drivers 6 = optional coil for 12V_{DC} Atos drivers 18 = optional coil for low current drivers</p> <p>Electronics options only for AEB and AES - see section 9: I = current reference input 4 ÷ 20 mA (omit for standard voltage reference input 0 ÷ 10 V) Q = enable signal Z = double power supply, enable, fault and monitor signals - 12 pin connector</p>																
<p>Max regulated pressure: 50 = 50 bar (not for KZGO) 210 = 210 bar 350 = 350 bar 100 = 100 bar 315 = 315 bar</p>																

(1) Omit for **A** execution; **AEB** available only in version **NP**; **AES** available only in version **BC, BP, EH**

2 ELECTRONIC DRIVERS

Valve model	A										AEB	AES
	E-MI-AC-01F		E-BM-AC-01F		E-ME-AC-01F	E-MI-AS-IR		E-BM-AS-PS		E-BM-AES	E-RI-AEB	E-RI-AES
Type	Analog					Digital						
Voltage supply (V _{DC})	12	24	12	24	24	12	24	12	24	24	24	
Valve coil option	/6	std	/6	std	std	/6	std	/6	std	std	std	
Format	plug-in to solenoid		DIN 43700 UNDECAL		EUROCARD	plug-in to solenoid		DIN-rail panel			Integral to valve	
Data sheet	G010		G025		G035	G020		G030	GS050		GS115	

Note: for main and communication connector see sections 12, 13

Hydraulic symbols

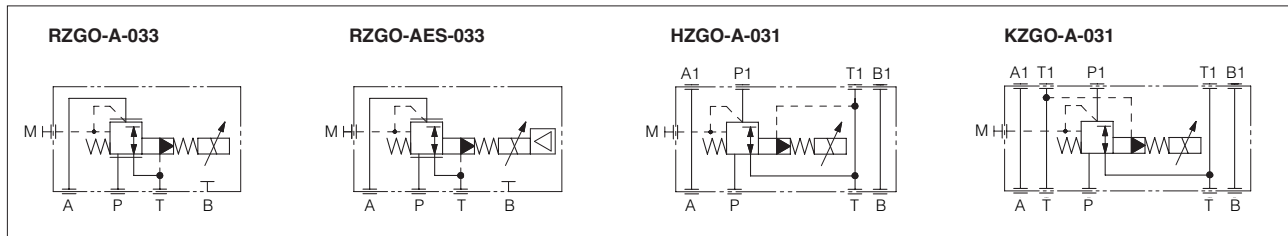

3 GENERAL NOTES

RZGO-A*, HZGO-A*, KZGO-A* proportional valves are CE marked according to the applicable Directives (e.g. Immunity/Emission EMC Directive and Low Voltage Directive).

Installation, wirings and start-up procedures must be performed according to the general prescriptions shown in table F003 and in the installation notes supplied with relevant components.

4 FIELDBUS - only for AES

Fieldbus allows the direct communication of the proportional valve with machine control unit for digital reference signal, diagnostics and settings of functional parameters. Analog reference signal remain available on the main connector for quick commissioning and maintenance. For detailed information about fieldbus features and specification see tech table **GS510**.

5 MAIN CHARACTERISTICS - based on mineral oil ISO VG 46 at 50 °C

Assembly position	Any position			
Subplate surface finishing	Roughness index, Ra 0,4 flatness ratio 0,01/100 (ISO 1101)			
MTTFd valves according to EN ISO 13849	75 years, see technical table P007			
Ambient temperature range	A: standard = -20°C ÷ +70°C,	/BT option = -40°C ÷ +60°C		
	AEB, AES: standard = -20°C ÷ +60°C,	/BT option = -40°C ÷ +60°C		
Storage temperature range	A: standard = -20°C ÷ +80°C,	/BT option = -40°C ÷ +70°C		
	AEB, AES: standard = -20°C ÷ +70°C,	/BT option = -40°C ÷ +70°C		
Coil resistance R at 20°C	Standard = 3 ÷ 3,3 Ω	Option /6 = 2 ÷ 2,2 Ω	Option /18 = 13 ÷ 13,4 Ω	
Max. solenoid current	Standard = 2,6 A	Option /6 = 3,25 A	Option /18 = 1,5 A	
Max. power	A = 30 Watt AEB, AES = 50 Watt			
Insulation class	H (180°) Due to the occurring surface temperatures of the solenoid coils, the European standards ISO 13732-1 and EN982 must be taken into account			
Protection degree to DIN EN60529	IP66/67 with mating connectors			
Tropicalization (only AEB, AES)	Tropical coating on electronics PCB			
Duty factor	Continuous rating (ED=100%)			
EMC, climate and mechanical load	See technical table G004			
Communication interface (only AEB, AES)	USB Atos ASCII coding	CANopen EN50325-4 + DS408	PROFIBUS DP EN50170-2/IEC61158	EtherCAT IEC 61158
Communication physical layer (only AEB, AES)	not insulated USB 2.0 + USB OTG	optical insulated CAN ISO11898	optical insulated RS485	Fast Ethernet, insulated 100 Base TX

Valve model	RZGO-A, -AE, -AES, HZGO-A					KZGO-A			
Max regulated pressure [bar]	50	100	210	315	350	100	210	315	350
Min. regulated pressure (1) [bar]	1,0 ; 3,0 (only for /350)								
Max. pressure at port P [bar]	350								
Max. pressure at port T [bar]	210								
Min. flow [l/min]	2,5					3			
Max. flow [l/min]	40					100			
Response time 0-100% step signal (2) [ms] (depending on installation)	≤ 50					≤ 80			
Hysteresis [% of the max pressure]	≤ 2								
Linearity [% of the max pressure]	≤ 3								
Repeatability [% of the max pressure]	≤ 2								

Notes: above performance data refer to valves coupled with Atos electronic drivers, see section 2

(1) Min pressure values to be increased of T line pressure

(2) Average response time value; the pressure variation in consequence of a modification of the reference input signal to the valve is affected by the stiffness of the hydraulic circuit: greater is the stiffness of the circuit, faster is the dynamic response

5 SEALS AND HYDRAULIC FLUID - for other fluids not included in below table, consult our technical office

Seals, recommended fluid temperature	NBR seals (standard) = -20°C ÷ +60°C, with HFC hydraulic fluids = -20°C ÷ +50°C FKM seals (/PE option) = -20°C ÷ +80°C HNBR seals (/BT option) = -40°C ÷ +60°C, with HFC hydraulic fluids = -40°C ÷ +50°C		
Recommended viscosity	20 ÷ 100 mm ² /s - max allowed range 15 ÷ 380 mm ² /s		
Fluid contamination class	ISO 4406 class 20/18/15 NAS 1638 class 9, in line filters of 10 µm (β10 ≥75 recommended)		
Hydraulic fluid	Suitable seals type	Classification	Ref. Standard
Mineral oils	NBR, FKM, HNBR	HL, HLP, HLPD, HVL, HVLDP	DIN 51524
Flame resistant without water	FKM	HFDU, HFDR	ISO 12922
Flame resistant with water	NBR, HNBR	HFC	

6 DIAGRAMS (based on mineral oil ISO VG 46 at 50 °C)

6.1 Regulation diagrams

with flow rate Q = 10 l/min

1 = RZGO, HZGO

2 = KZGO

Note:

The presence of counter pressure at port T can affect the effective pressure regulation.

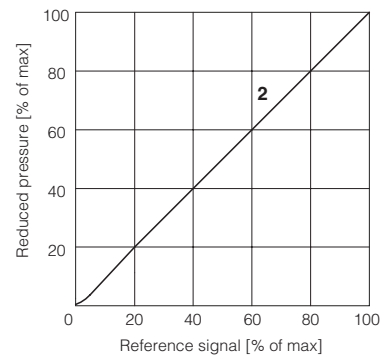
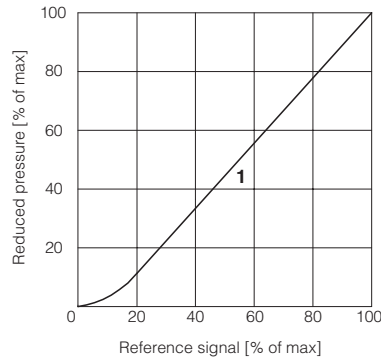

6.2 Pressure/flow diagrams

with reference pressure set with Q = 10 l/min

3 = RZGO, KZGO

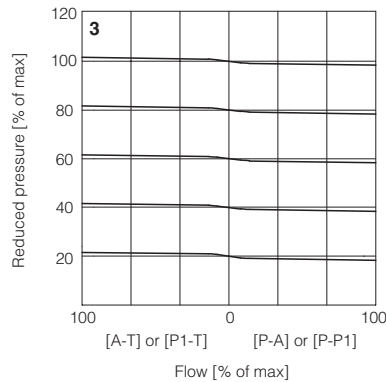

6.3 Pressure drop/flow diagram

RZGO, HZGO

4 = A-T or P1-T (dotted line /350)

5 = P-P1 or P-A

KZGO

6 = P1-T (dotted line /350)

7 = P-P1

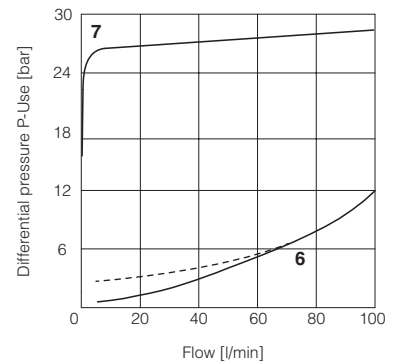
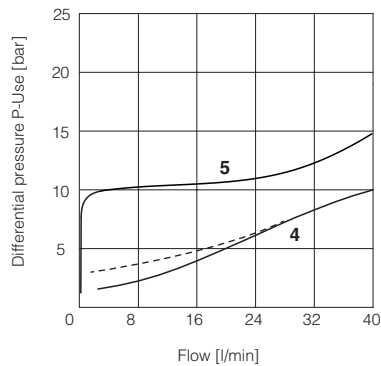

7 OPTIONS FOR -A EXECUTION

7.1 Option /6 optional coil to be used with Atos drivers with power supply 12 V_{DC}

7.2 Option /18 optional coil to be used with electronic drivers not supplied by Atos

8 AIR BLEEDING

At the first valve commissioning the air eventually trapped inside the solenoid must be bled-off through the screw ① located at the rear side of the solenoid housing.

The presence of air may cause pressure instability and vibrations.

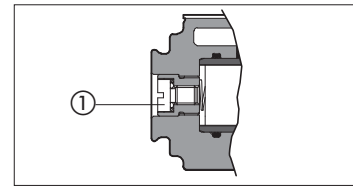

9 ELECTRONIC OPTIONS

Standard driver execution provides on the 7 pin main connector:

Power supply - 24 V_{DC} must be appropriately stabilized or rectified and filtered; a 2,5 A fuse time lag is required in series to each driver power supply. Apply at least a 10000 µF/40 V capacitance to single phase rectifiers or a 4700 µF/40 V capacitance to three phase rectifiers

Reference input signal - analog differential input with 0÷+10 V_{DC} nominal range (pin D, E), proportional to desired valve pressure regulation

Monitor output signal - analog output signal proportional to the actual valve's coil current (1V monitor = 1A coil current)

Note: a minimum booting time of 500 ms has been considered from the driver energizing with the 24 V_{DC} power supply before the valve has been ready to operate. During this time the current to the valve coils is switched to zero.

9.1 Option /I

It provides 4 ÷ 20 mA current reference signal, instead of the standard 0÷+10 V_{DC}.

Input signal can be reconfigured via software selecting between voltage and current, within a maximum range of ±10 V or ±20 mA.

It is normally used in case of long distance between the machine control unit and the valve or where the reference signal can be affected by electrical noise; the valve functioning is disabled in case of reference signal cable breakage

9.2 Option /Q

To enable the driver, supply 24 V_{DC} on pin C referred to pin B: Enable input signal allows to enable/disable the current supply to the solenoid, without removing the electrical power supply to the driver; it is used to maintain active the communication and the other driver functions when the valve has to be disabled. This condition does not comply with European Norms EN13849-1 (ex EN954-1).

9.3 Option /Z

It provides, on the 12 pin main connector, the following additional features:

Enable Input Signal

To enable the driver, supply 24 V_{DC} on pin 3 referred to pin 2: Enable input signal allows to enable/disable the current supply to the solenoid, without removing the electrical power supply to the driver; it is used to maintain active the communication and the other driver functions when the valve has to be disabled. This condition does not comply with European Norms EN13849-1 (ex EN954-1).

Fault Output Signal

Fault output signal indicates fault conditions of the driver (solenoid short circuits/not connected, reference signal cable broken for 4÷20mA input, etc.). Fault presence corresponds to 0 V_{DC}, normal working corresponds to 24 V_{DC} (pin 11 referred to pin 2): Fault status is not affected by the Enable input signal

Power supply for driver's logics and communication

Separate power supply (pin 9, 10) allow to cut solenoid power supply (pin 1,2) while maintaining active diagnostics, USB and fieldbus communication.

A safety fuse is required in series to each driver power supply: 500 mA fast fuse.

9.4 Possible combined options: /IQ, /IZ

10 PROGRAMMING TOOLS - see tech table GS500

Valve's functional parameters and configurations, can be easily set and optimized using Atos E-SW programming software connected via USB port to the digital driver. For fieldbus versions, the software permits valve's parameterization through USB port also if the driver is connected to the central machine unit via fieldbus.

The software is available in different versions according to the driver's options:

E-SW-BASIC support: NP (USB) PS (Serial) IR (Infrared)

E-SW-FIELDBUS support: BC (CANopen) BP (PROFIBUS DP) EH (EtherCAT)

EW (POWERLINK) EI (EtherNet/IP)

E-SW-*/PQ support: valves with SP, SF, SL alternated control (e.g. E-SW-BASIC/PQ)

WARNING: drivers USB port is not isolated!

The use of isolator adapter is highly recommended for PC protection (see table GS500)

USB connection

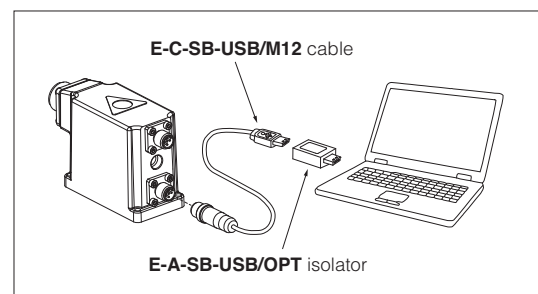

11 ELECTRONIC CONNECTIONS

11.1 Main connector signals - 7 pin - standard and /Q option - RZGO-AEB and RZGO-AES (A1)

PIN	Standard	/Q	TECHNICAL SPECIFICATIONS	NOTES
A	V+		Power supply 24 Vdc Rectified and filtered: $V_{RMS} = 20 \div 32 V_{MAX}$ (ripple max 10 % V_{PP})	Input - power supply
B	V0		Power supply 0 Vdc	Gnd - power supply
C	AGND		Analog ground	Gnd - analog signal
		ENABLE	Enable (24 Vdc) or disable (0 Vdc) the driver, referred to V0	Input - on/off signal
D	INPUT+		Pressure reference input signal: $\pm 10 V_{dc} / \pm 20 mA$ maximum range Defaults are $0 \div 10 V_{dc}$ for standard and $4 \div 20 mA$ for /I option	Input - analog signal Software selectable
E	INPUT-		Negative reference input signal for P_INPUT+	Input - analog signal
F	MONITOR referred to: AGND V0		Pressure monitor output signal: $\pm 5 V_{dc}$ maximum range Default is $0 \div 5 V_{dc}$ ($1V = 1A$)	Output - analog signal Software selectable
G	EARTH		Internally connected to driver housing	

11.2 Main connector signals - 12 pin - /Z option - RZGO-AEB and RZGO-AES (A2)

PIN	/Z	TECHNICAL SPECIFICATIONS	NOTES
1	V+	Power supply 24 Vdc Rectified and filtered: $V_{RMS} = 20 \div 32 V_{MAX}$ (ripple max 10 % V_{PP})	Input - power supply
2	V0	Power supply 0 Vdc	Gnd - power supply
3	ENABLE	Enable (24 Vdc) or disable (0 Vdc) the driver, referred to V0	Input - on/off signal
4	INPUT+	Pressure reference input signal: $\pm 10 V_{dc} / \pm 20 mA$ maximum range Defaults are $0 \div 10 V_{dc}$ for standard and $4 \div 20 mA$ for /I option	Input - analog signal Software selectable
5	INPUT-	Negative reference input signal for P_INPUT+	Input - analog signal
6	MONITOR	Pressure monitor output signal: $\pm 5 V_{dc}$ maximum range Defaults is $0 \div 5 V_{dc}$ ($1V = 1A$)	Output - analog signal Software selectable
7	NC	Do not connect	
8	NC	Do not connect	
9	VL+	Power supply 24 Vdc for driver's logic and communication	Input - power supply
10	VLO	Power supply 0 Vdc for driver's logic and communication	Gnd - power supply
11	FAULT	Fault (0 Vdc) or normal working (24 Vdc), referred to V0	Output - on/off signal
PE	EARTH	Internally connected to driver housing	

11.3 Communication connectors - RZGO-AEB (B) and RZGO-AES (B) (C)

(B) USB connector - M12 - 5 pin always present		
PIN	SIGNAL	TECHNICAL SPECIFICATION (1)
1	+5V_USB	Power supply
2	ID	Identification
3	GND_USB	Signal zero data line
4	D-	Data line -
5	D+	Data line +

(C1) BC fieldbus execution, connector - M12 - 5 pin (2)		
PIN	SIGNAL	TECHNICAL SPECIFICATION (1)
1	CAN_SHLD	Shield
2	NC	do not connect
3	CAN_GND	Signal zero data line
4	CAN_H	Bus line (high)
5	CAN_L	Bus line (low)

(C2) BP fieldbus execution, connector - M12 - 5 pin (2)		
PIN	SIGNAL	TECHNICAL SPECIFICATION (1)
1	+5V	Termination supply signal
2	LINE-A	Bus line (high)
3	DGND	Data line and termination signal zero
4	LINE-B	Bus line (low)
5	SHIELD	

(C3) (C4) EH fieldbus execution, connector - M12 - 4 pin (2)		
PIN	SIGNAL	TECHNICAL SPECIFICATION (1)
1	TX+	Transmitter
2	RX+	Receiver
3	TX-	Transmitter
4	RX-	Receiver
Housing	SHIELD	

Notes: (1) shield connection on connector's housing is recommended (2) only for AES execution

11.4 Solenoid connection - only for RZGO-A, HZGO-A, KZGO,A

PIN	SIGNAL	TECHNICAL SPECIFICATION	Connector code 666
1	COIL	Power supply	
2	COIL	Power supply	
3	GND	Ground	

11.5 Connections layout - only for AEB and AES

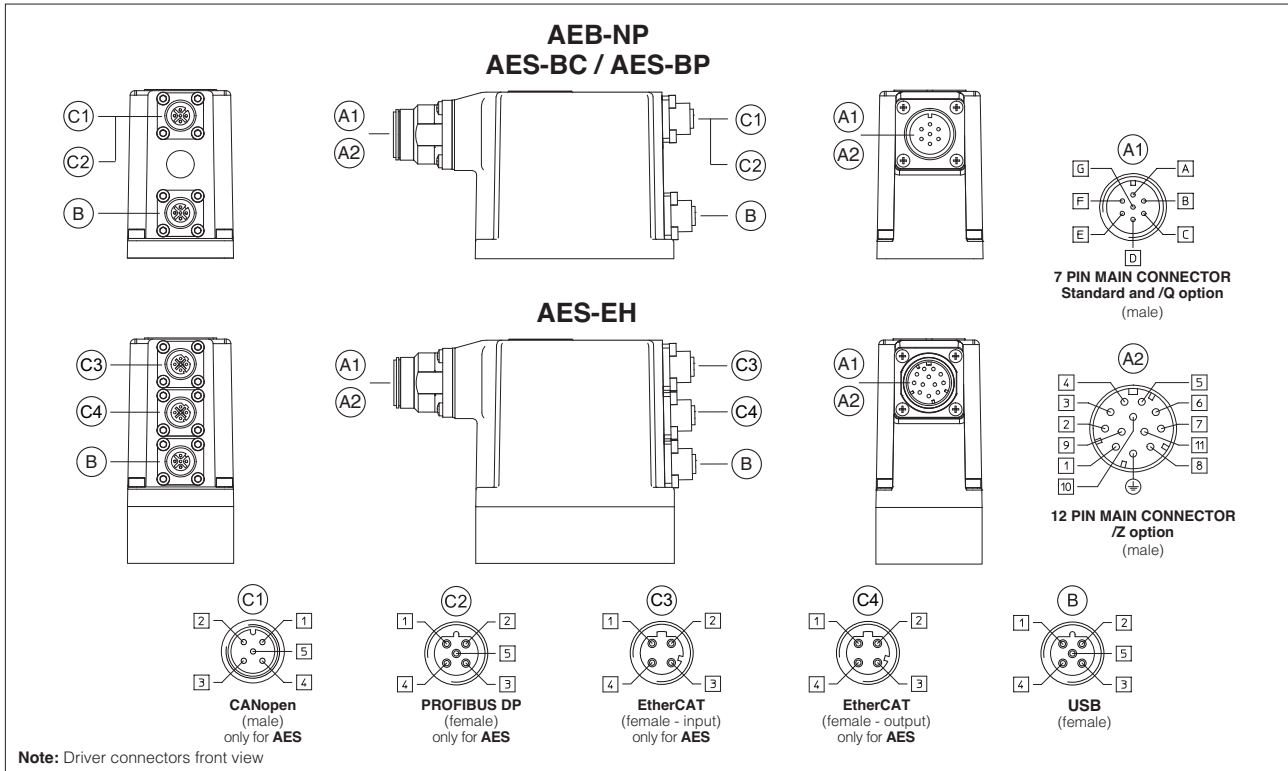

12 CONNECTORS

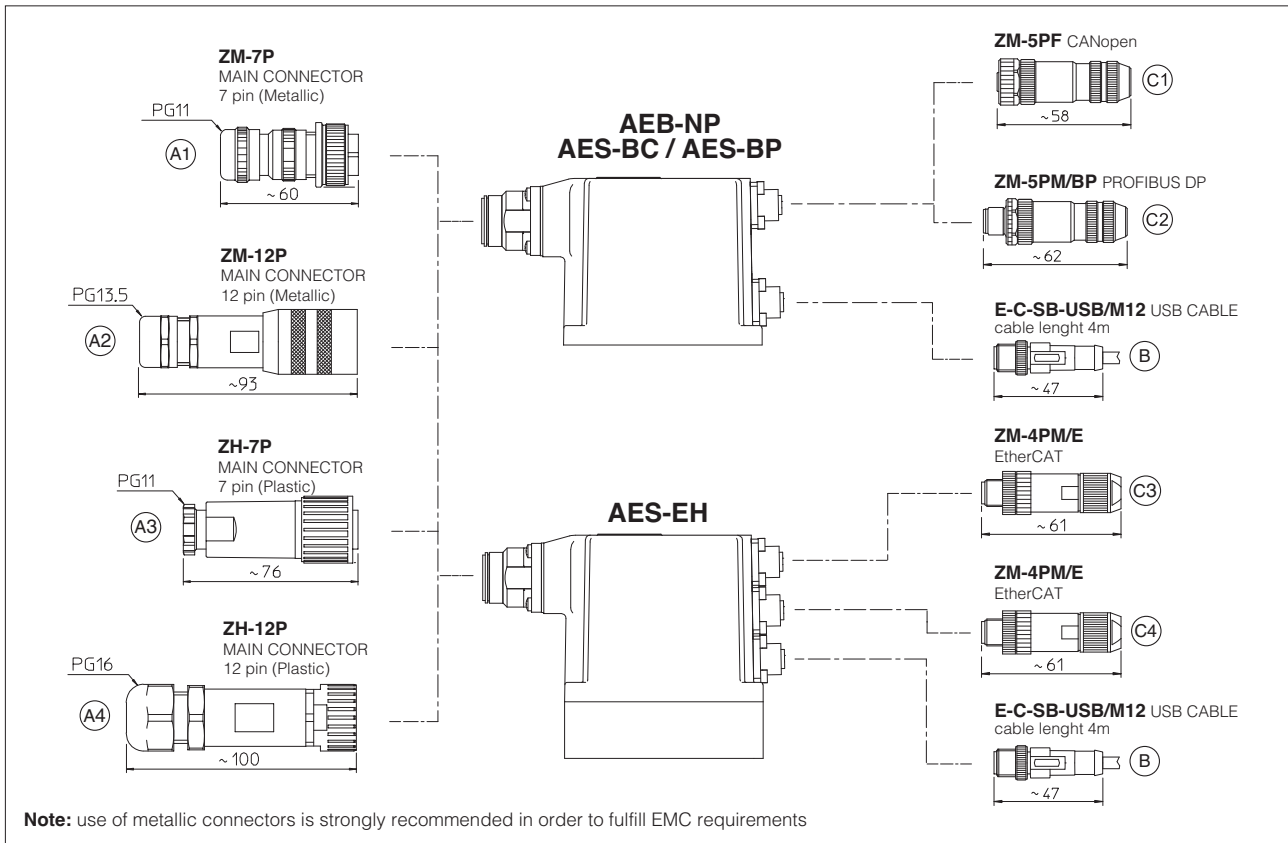

13 MODEL CODES OF MAIN CONNECTORS AND COMMUNICATION CONNECTORS - to be ordered separately

VALVE VERSION	A (1) Power supply	AEB AES	AEB/Z AES/Z	BC - CANopen	BP - PROFIBUS DP	EH - EtherCAT
CONNECTOR CODE	666	ZM-7P (A1)	ZM-12P (A2)	ZM-5PF (C1)	ZM-5PM/BP (C2)	ZM-4PM/E (C3)
		ZH-7P (A3)	ZH-12P (A4)			ZM-4PM/E (C4)
PROTECTION DEGREE	IP67	IP67				
DATA SHEET	K500	GS115, K500				

(1) Connectors supplied with the valve

only for AES

14 INSTALLATION DIMENSIONS [mm]

ISO 4401: 2000

Mounting surface: 4401-03-02-0-05
(see table P005)

Fastening bolts:
4 socket head screws M5X50 bolts class 12.9
Tightening torque = 8 Nm
Seals: 4 OR 108
Ports P, A, T: $\varnothing = 7,5$ mm
Port B not used

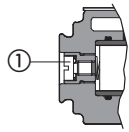
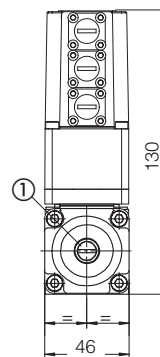
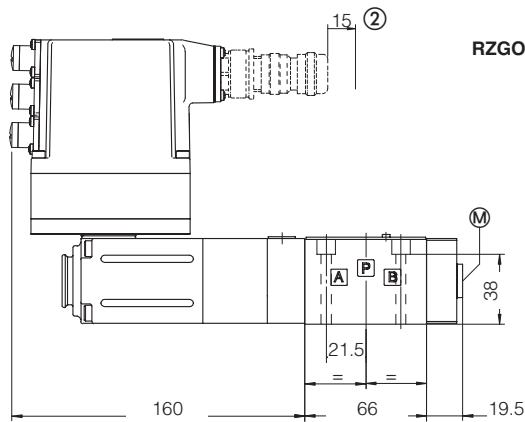
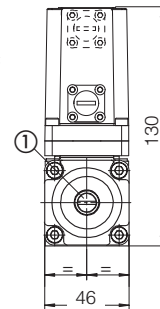
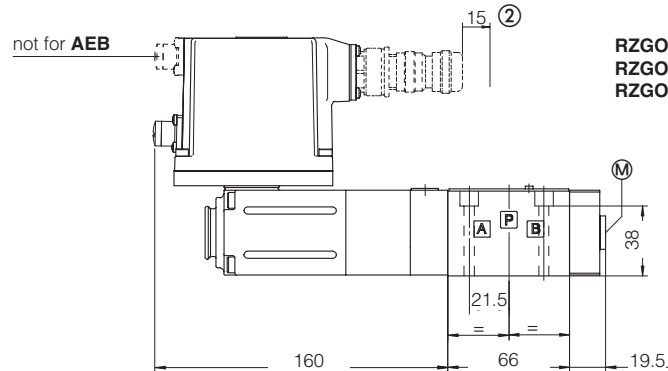
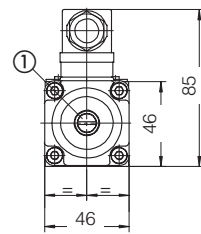
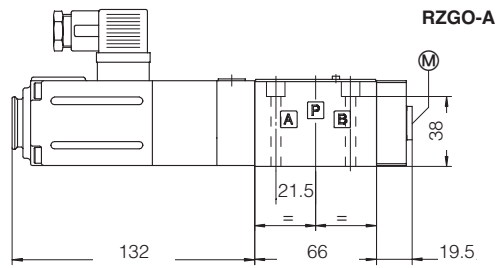

ISO 4401: 2000

Mounting surface: 4401-03-02-0-05
(see tab. P005)

Fastening bolts: M5 class 12.9
Tightening torque = 8 Nm
Seals: 4 OR 108
Ports P, A, B, T: $\varnothing = 6,5$ mm

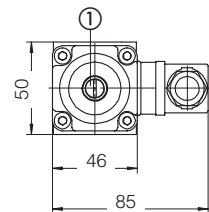
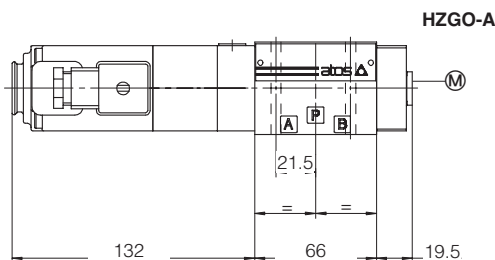

ISO 4401: 2000

Mounting surface: 4401-05-04-0-05
(see tab. P005)

Fastening bolts: M6 class 12.9
Tightening torque = 15 Nm
Seals: 5 OR 2050.1 OR 108
Ports P,A,B,T: $\varnothing = 10,5$ mm (max)

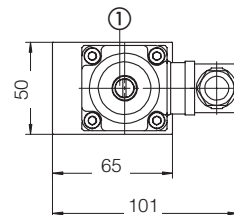
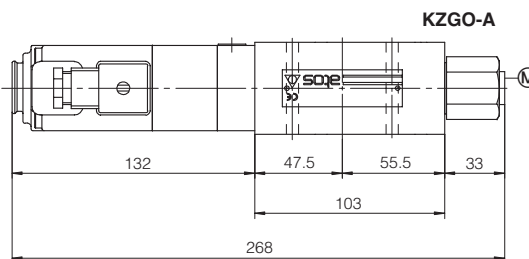

Ⓜ = Pressure gauge connection port = G1/4"

① = Screw for air bleeding: at the first valve commissioning the air eventually trapped inside the solenoid must be bled-off though the screw ①

② = Space to remove the 7 or 12 pin main connector. For main and communication connectors see section 12, 13