

Pressure relief valves type **SAGAM**

two stage, subplate mounting - ISO 6264 size 10, 20 and 32

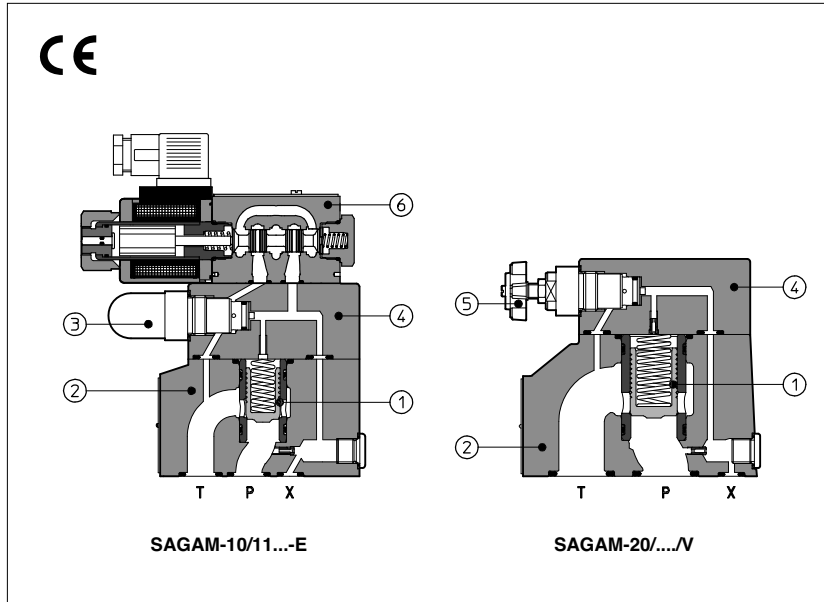

SAGAM are two stage pressure relief valves with balanced poppet, designed to operate in oil hydraulic systems.

In standard versions the piloting pressure of the poppet (1) of the main stage (2) is regulated by means of a grub screw protected by cap (3) in the cover (4).

Optional versions with setting adjustment by handwheel (5) instead of the grub screw are available on request.

Clockwise rotation increases the pressure.

SAGAM can be equipped with a SDHE pilot solenoid valve (6) for venting

Mounting surface: **ISO 6264 size 10, 20 and 32**

Max flow: **200, 400 and 600 l/min**

Max pressure up to **350 bar**

1 MODEL CODE

SAGAM	-	20	/	10	/	210	/	V	-	E	X	24DC	**	/	*
<p>SAGAM = pressure relief valve subplate mounting</p> <p>Size: 10 20 32</p> <p>Venting option: - = without venting 10=venting with de-energized solenoid 11=venting with energized solenoid</p> <p>Setting: see section 3 for available setting</p> <p>Options, see section 5 E V WP Y</p>															
<p>Seals material, see section 4: - = NBR PE = FKM BT = HNBR</p> <p>Series number</p> <p>Voltage code, see section 7 (1):</p> <p>X = without connector (1): See section 6 for available connectors, to be ordered separately -00-AC = AC solenoid valve without coils -00-DC = DC solenoid valve without coils</p> <p>Solenoid venting valve (1): E = SDHE for AC and DC supply with cURus certified solenoids</p>															

(1) Only for SAGAM with solenoid valve for venting.

2 HYDRAULIC SYMBOLS

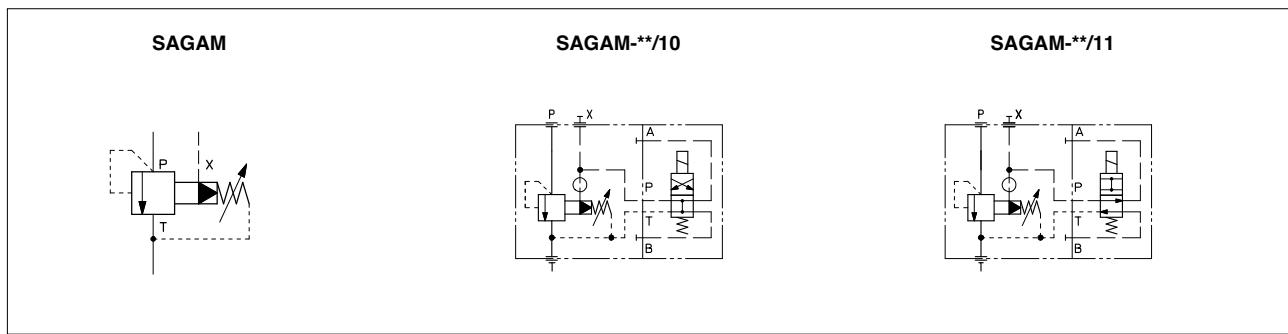

3 HYDRAULIC CHARACTERISTICS

Valve model	SAGAM-10	SAGAM-20	SAGAM-32
Setting [bar]	50;	100; 210;	350
Pressure range [bar]	4÷50;	6÷100;	7÷210; 8÷350
Max pressure [bar]	ports P, X = 350 Ports T, Y = 210 (without pilot solenoid valve) For version with pilot solenoid valve, see technical tables SHE015		
Max flow [l/min]	200	400	600

4 MAIN CHARACTERISTICS, SEALS AND FLUIDS - for other fluids not included in below table, consult our technical office

Assembly position	Any position		
Subplate surface finishing	Roughness index Ra 0,4 - flatness ratio 0,01/100 (ISO 1101)		
Ambient temperature	Standard execution = -30°C ÷ +70°C /PE option = -20°C ÷ +70°C /BT option = -40°C ÷ +70°C		
Seals, recommended fluid temperature	NBR seals (standard) = -20°C ÷ +80°C, with HFC hydraulic fluids = -20°C ÷ +50°C FKM seals (/PE option) = -20°C ÷ +80°C HNBR seals (/BT option) = -40°C ÷ +60°C, with HFC hydraulic fluids = -40°C ÷ +50°C		
Recommended viscosity	15÷100 mm ² /s - max allowed range 2,8 ÷ 500 mm ² /s		
Fluid contamination class	ISO 4406 class 21/19/16 NAS 1638 class 10, achievable with in line filters - 25 µm (β10 ≥75 recommended)		
Hydraulic fluid	Suitable seals type	Classification	Ref. Standard
Mineral oils	NBR, FKM, HNBR	HL, HLP, HLPD, HVL, HVLDP	DIN 51524
Flame resistant without water	FKM	HFDR, HFDR	ISO 12922
Flame resistant with water	NBR, HNBR	HFC	

4.1 Coils characteristics (for SAGAM with solenoid venting valve)

Insulation class	H (180°C) for DC coils F (155°C) for AC coils	Due to the occurring surface temperatures of the solenoid coils, the European standards EN ISO 13732-1 and EN ISO 4413 must be taken into account
Protection degree to DIN EN 60529	IP 65 (with connectors 666, 667, 669 correctly assembled)	
Relative duty factor	100%	
Supply voltage and frequency	See electric feature 8	
Supply voltage tolerance	± 10%	
Certification	cURus North American standard	

5 OPTIONS

- /E** = external pilot
- /V** = regulating handwheel instead of grub screw protected by cap
- /WP** = prolonged manual override protected by rubber cap (only for SAGAM with pilot solenoid valve)
- /Y** = external drain (only for SAGAM with pilot solenoid valve)

6 ELECTRIC CONNECTORS ACCORDING TO DIN 43650 FOR SAGAM WITH SOLENOID VALVE

The connectors must be ordered separately

Code of connector	Function
666	Connector IP-65, suitable for direct connection to electric supply source
667	As 666 connector IP-65 but with built-in signal led, suitable for direct connection to electric supply source

7 ELECTRIC FEATURES FOR SAGAM WITH SOLENOID VALVE

Solenoid valve type	External supply nominal voltage $\pm 10\%$ (1)		Voltage code	Type of connector	Power consumption (3) SDHE	Code of spare coil SDHE
SDHE	DC	12 DC 24 DC 110 DC 220 DC	12 DC 24 DC 110 DC 220 DC	666 or 667	30 W	COE-12DC COE-24DC COE-110DC COE-220DC
		AC	110/50 AC (2) 115/60 AC 230/50 AC (2) 230/60 AC	110/50/60 AC 115/60 AC 230/50/60 AC 230/60 AC	666 or 667	58 VA 80 VA 58 VA (4) 80 VA

(1) For other supply voltages available on request see technical tables SHE015.

(2) Coil can be supplied also with 60 Hz of voltage frequency: in this case the performances are reduced by 10 ÷ 15% and the power consumption is 55 VA

(3) Average values based on tests performed at nominal hydraulic condition and ambient/coil temperature of 20°C.

(4) When AC solenoid is energized, the inrush current is approx 3 times the holding current.

8 REGULATED PRESSURE VERSUS FLOW DIAGRAMS based on mineral oil ISO VG 46 at 50°C

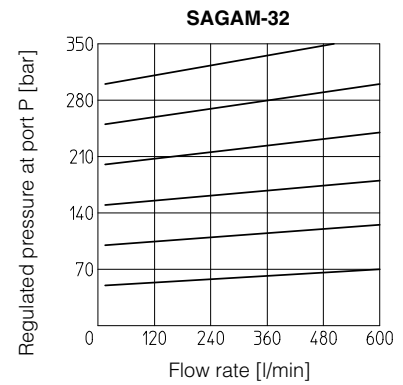
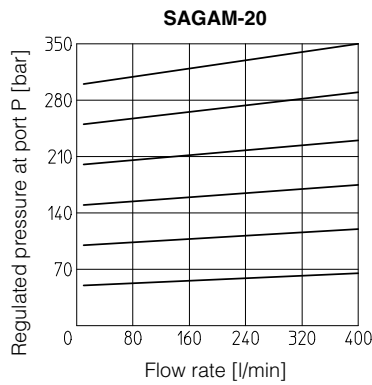
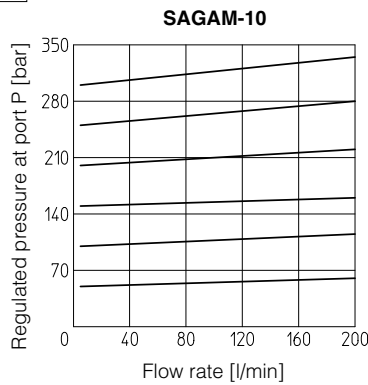

9 MINIMUM PRESSURE VERSUS FLOW DIAGRAMS based on mineral oil ISO VG 46 at 50°C

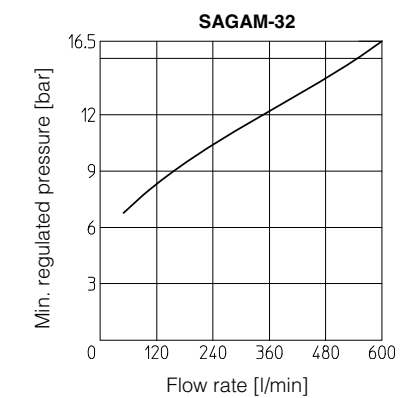
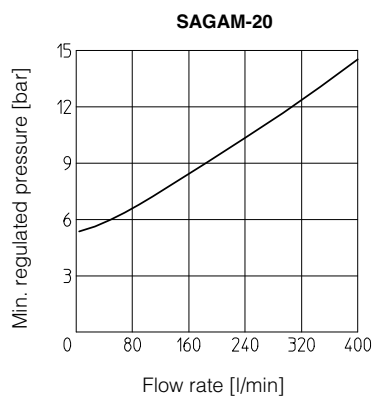
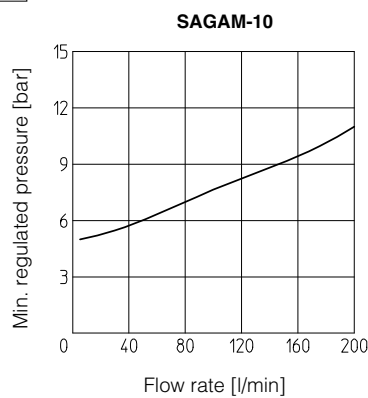

SAGAM-10

ISO 6264: 2007

Mounting surface: 6264-06-09-1-97

Fastening bolts:

4 socket head screws M12x35 class 12.9

Tightening torque = 125 Nm

Seals: 2 OR 123; 1 OR 109/70

Ports P, T: $\varnothing = 14,5$ mm

Ports X: $\varnothing = 3,2$ mm

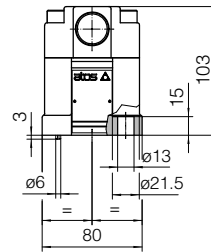
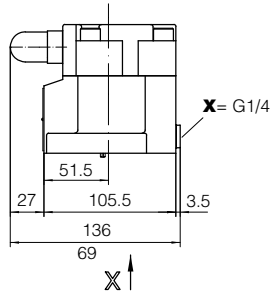

Mass: 3,6 Kg

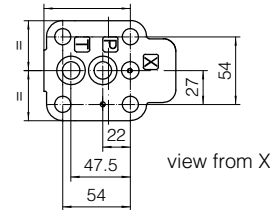

view from X

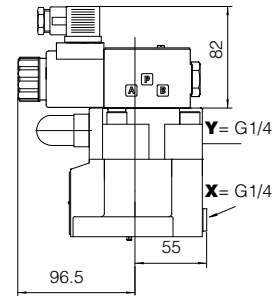

SAGAM-10/10/**-EX
SAGAM-10/11/**-EX

Mass: 5,1 Kg

SAGAM-20

ISO 6264: 2007

Mounting surface: 6264-08-11-1-97

Fastening bolts:

4 socket head screws M16x50 class 12.9

Tightening torque = 300 Nm

Seals: 2 OR 4112; 1 OR 109/70

Ports P, T: $\varnothing = 24$ mm

Ports X: $\varnothing = 3,2$ mm

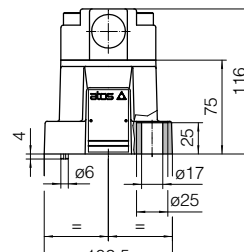
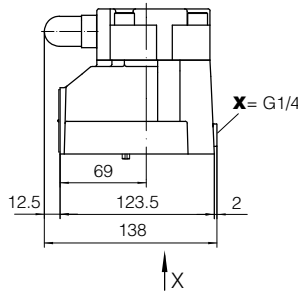

Mass: 4,8Kg

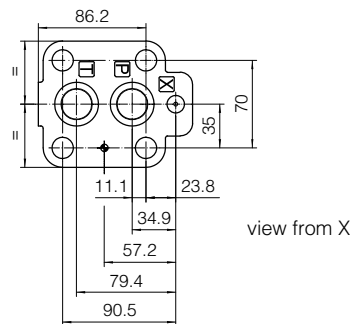

view from X

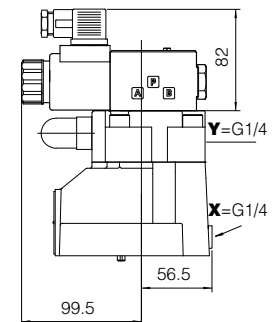

SAGAM-20/10/**-EX
SAGAM-20/11/**-EX

Mass: 6,3 Kg

SAGAM-32

ISO 6264: 2007

Mounting surface: 6264-10-17-1-97
(with M20 fixing holes instead of standard M18)

Fastening bolts:

4 socket head screws M20x60 class 12.9

Tightening torque = 600 Nm

Seals: 2 OR 4131; 1 OR 109/70

Ports P, T: $\varnothing = 28,5$ mm

Ports X: $\varnothing = 3,2$ mm

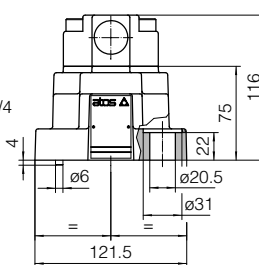
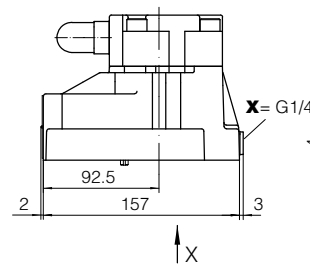

Mass: 6,2 Kg

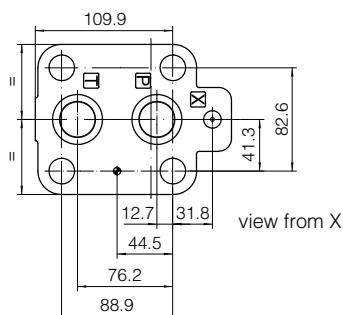

view from X

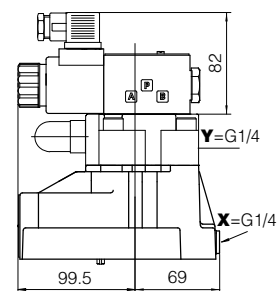

SAGAM-32/10/**-EX
SAGAM-32/11/**-EX

Mass: 7,7 Kg

Overall dimensions refer to valves with connectors type 666