

Flow restrictor valves type **AQFR**

in-line mounting - from G 3/8" to G 1 1/4" threaded ports

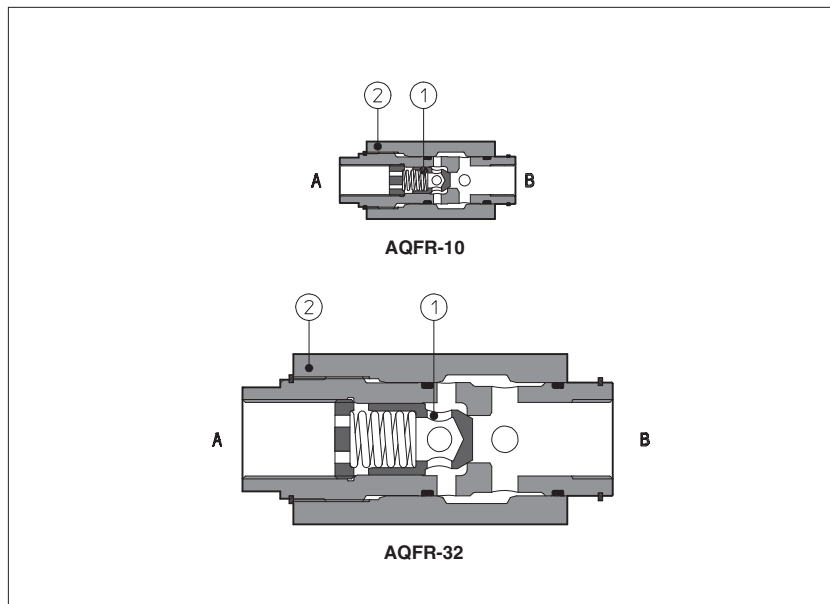

AQFR are not compensated flow throttling valves with a built-in check valve ① to allow the free flow in the opposite direction.

The flow adjustment is done by turning the external exagon ②. Clockwise rotation increases the throttling (reduced passage). The regulated flow is a function of the pressure drop existing between the inlet and outlet ports.

They are available in five sizes: from 3/8" to 1 1/4" GAS with flow up 30, 50, 80, 160, 250 l/min respectively and pressure up to 400/350 bar (depending on size).

Max pressure: **350 bar**

1 MODEL CODE

AQF	R	-	10
Throttling valve in-line mounting			
R = with check valve for free reverse flow			
Size and ports dimensions:			
10 = G 3/8"	15 = G 1/2"	20 = G 3/4"	25 = G 1" 32 = G 1 1/4"

**	/	*
Series number		
Seals material, see section 8: - = NBR PE = FKM BT = HNBR		

2 HYDRAULIC CHARACTERISTICS

Hydraulic symbol

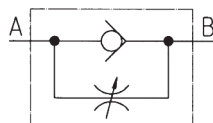

Valve model	AQFR-10	AQFR-15	AQFR-20	AQFR-25	AQFR-32
Max recommended flow [l/min]	30	50	80	160	250
Max pressure [bar]	400	350			

3 MAIN CHARACTERISTICS, SEALS AND FLUIDS - for other fluids not included in below table, consult our technical office

Assembly position	Any position			
Ambient temperature	Standard execution = -30°C ÷ +70°C; /PE option = -20°C ÷ +70°C; /BT option = -40°C ÷ +70°C			
Seals, recommended fluid temperature	NBR seals (standard) = -20°C ÷ +60°C, with HFC hydraulic fluids = -20°C ÷ +50°C FKM seals (/PE option) = -20°C ÷ +80°C HNBR seals (/BT option) = -40°C ÷ +60°C, with HFC hydraulic fluids = -40°C ÷ +50°C			
Recommended viscosity	15 ÷ 100 mm ² /s - max allowed range 2,8 ÷ 500 mm ² /s			
Fluid contamination class	ISO 4406 class 21/19/16 NAS 1638 class 10, in line filters of 25 μm (β ₂₅ ≥ 75 recommended)			
	Hydraulic fluid	Suitable seals type	Classification	Ref. Standard
Mineral oils	NBR, FKM, HNBR	HL, HLP, HLPD, HVLP, HVLPD	HFC	DIN 51524
Flame resistant without water	FKM	HFDR, HFDR		
Flame resistant with water	NBR, HNBR			ISO 12922

4 DIAGRAMS based on mineral oil ISO VG 46 at 50°C

4.1 Q/Δp diagram through the chec valve for free flow B→A with the throttle valve fully open and fully closed

- 1 = AQFR-10 fully closed
- 2 = AQFR-10 fully open
- 3 = AQFR-15 fully closed
- 4 = AQFR-15 fully open
- 5 = AQFR-20 fully closed
- 6 = AQFR-20 fully open
- 7 = AQFR-25 fully closed
- 8 = AQFR-25 fully open
- 9 = AQFR-32 fully closed
- 10 = AQFR-32 fully open

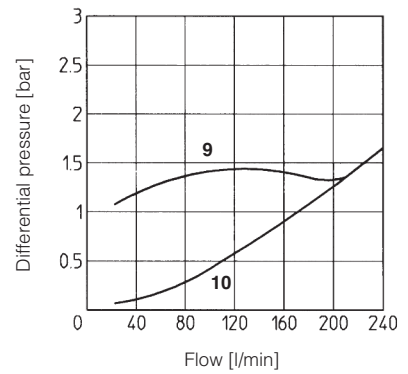
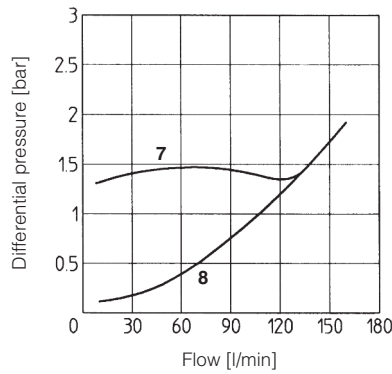
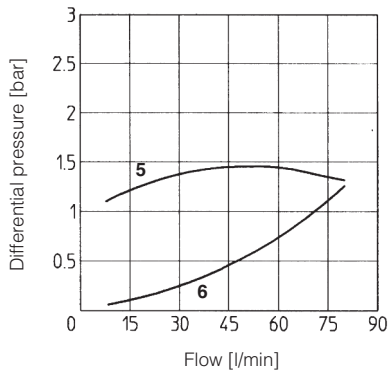
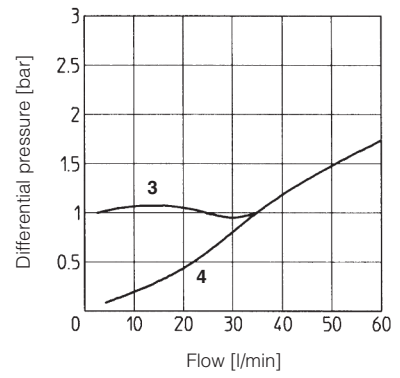
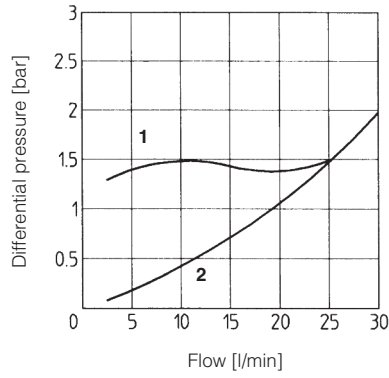

5 DIMENSIONS [mm]

Valve model	A	B	C	ØD	ØE	F	G	H	Mass [Kg]
AQFR-10	93	68	G 3/8"	28	25	13	24	41	0,7
AQFR-15	105	78	G 1/2"	32	30	15	27	46	1
AQFR-20	127	95,5	G 3/4"	36	34	17	32	55	1,6
AQFR-25	153	112	G 1"	48	45	19	42	75	3,5
AQFR-32	196	145	G 1 1/4"	63	60	21	55	90	6,5