

2 HYDRAULIC CHARACTERISTICS

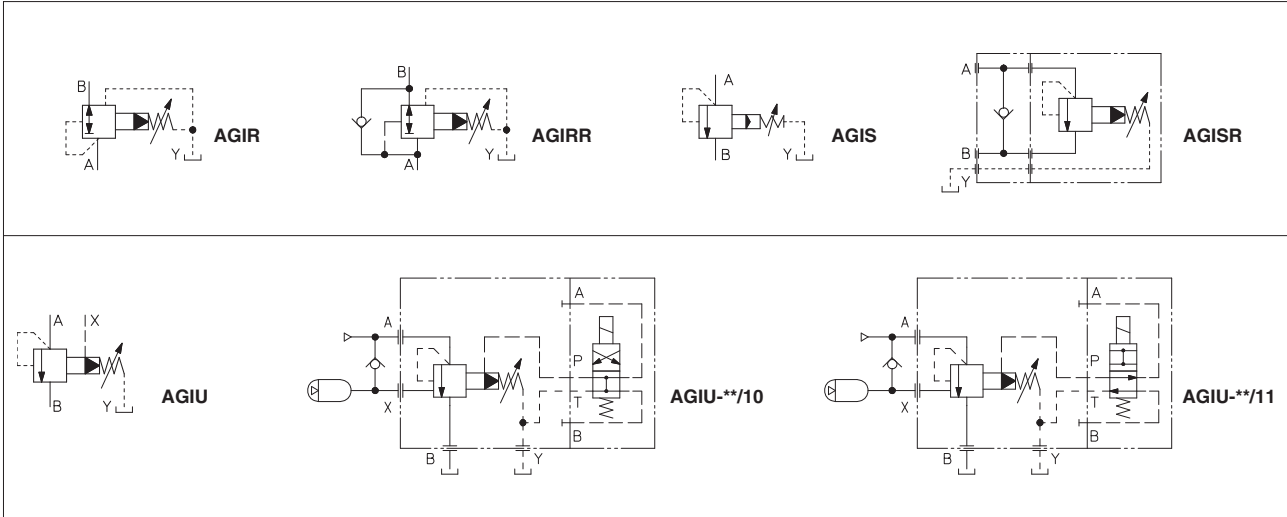

Valve model	AGIR-10	AGIR-20	AGIR-32	AGIS-10	AGIS-20	AGIS-32	AGIU-10	AGIU-20	AGIU-32
Max flow [l/min]	160	300	400	200	400	600	100	200	300
Pressure range [bar]	4÷50 (AGIR*);			6÷100;		7÷210;	8÷350		
Max pressure [bar]	Ports A, B, X = 350 bar					Port Y = 0			

3 MAIN CHARACTERISTICS, SEALS AND FLUIDS - for other fluids not included in below table, consult our technical office

Assembly position	Any position		
Subplate surface finishing	Roughness index Ra 0,4 - flatness ratio 0,01/100 (ISO 1101)		
Ambient temperature	Standard execution = -30°C ÷ +70°C /PE option = -20°C ÷ +70°C /BT option = -40°C ÷ +70°C		
Seals, recommended fluid temperature	NBR seals (standard) = -20°C ÷ +60°C, with HFC hydraulic fluids = -20°C ÷ +50°C FKM seals (/PE option) = -20°C ÷ +80°C HNBR seals (/BT option) = -40°C ÷ +60°C, with HFC hydraulic fluids = -40°C ÷ +50°C		
Recommended viscosity	15 ÷ 100 mm ² /s - max allowed range 2,8 ÷ 500 mm ² /s		
Fluid contamination class	ISO 4406 class 21/19/16 NAS 1638 class 10, in line filters of 25 µm (β ₂₅ ≥ 75 recommended)		
Hydraulic fluid	Suitable seals type	Classification	Ref. Standard
Mineral oils	NBR, FKM, HNBR	HL, HLP, HLPD, HVL, HVLPD	DIN 51524
Flame resistant without water	FKM	HF, HFD, HFDR	ISO 12922
Flame resistant with water	NBR, HNBR	HFC	

3.1 Coils characteristics

Insulation class	DHI pilot	H (180°C)	Due to the occurring surface temperatures of the solenoid coils, the European standards EN ISO 13732-1 and EN ISO 4413 must be taken into account
	DHE pilot	H (180°C) for DC coils F (155°C) for AC coils	
Protection degree to DIN EN 60529	IP 65 (with connectors 666, 667, 669 or E-SD correctly assembled)		
Relative duty factor	100%		
Supply voltage and frequency	See electric feature		
Supply voltage tolerance	± 10%		
Certification	cURus North American standard		

4 REGULATED PRESSURE VERSUS FLOW DIAGRAMS based on mineral oil ISO VG 46 at 50°C

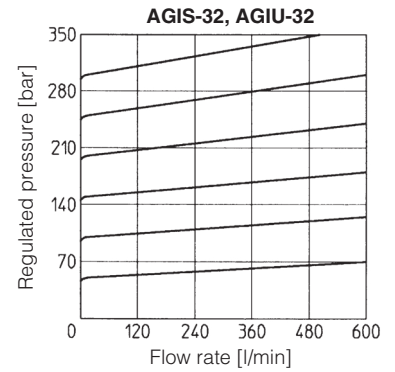
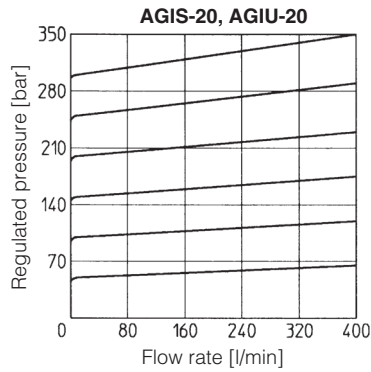
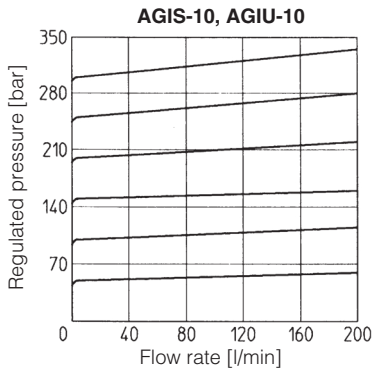
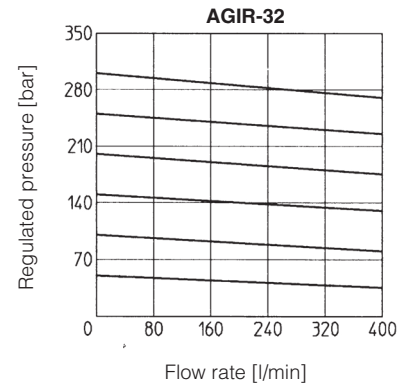
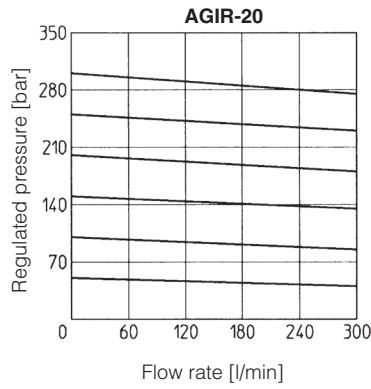
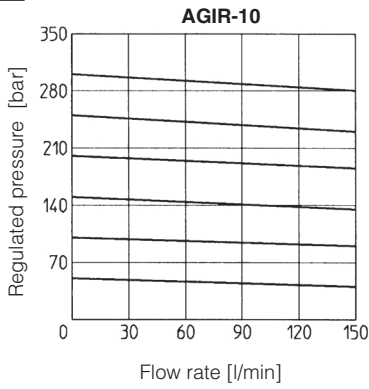

Note: for AGIU-10, the max flow rate is 100 l/min

Note: for AGIU-20, the max flow rate is 200 l/min

Note: for AGIU-32, the max flow rate is 300 l/min

5 OPERATING DIAGRAM based on mineral oil ISO VG 46 at 50°C

- 1 = AGIR-10 A Ø B
- 2 = AGIR-20 A Ø B
- 3 = AGIR-32 A Ø B
- 4 = AGIR-10 B Ø A
- 5 = AGIR-20 B Ø A
- 6 = AGIR-32 B Ø A
- 7 = AGIS-10
- 8 = AGIS-20

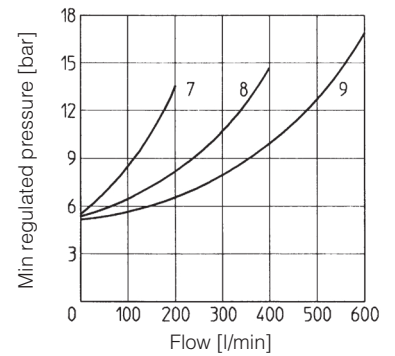
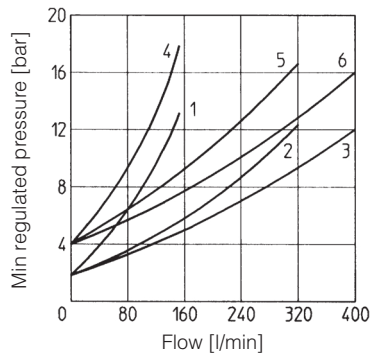

Opening/closing diagram for AGIU

- 1 = AGIU-*/... (standard) 3 = AGIU-*/.../6
- 2 = AGIU-*/.../5 4 = AGIU-*/.../7

NOTES

- 1) Short pipes with low resistance must be used between the unloading valve and the accumulator;
- 2) When the resistance is high, the hydraulic pilot signal must be taken as closed as possible to the accumulator;
- 3) With high pump flow and small valve differential pressure of intervention it is unadvisable to use the version with external drain;
- 4) When to use the BA-*25 subplates:
 - a) in applications with working frequencies >10 Hz use subplates type BA-*25/4 (spring with 4 bar of cracking pressure);
 - b) in applications with working frequencies <10 Hz use subplates type BA-*25/2 (spring with 2 bar of cracking pressure);

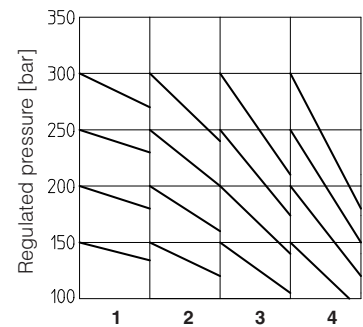
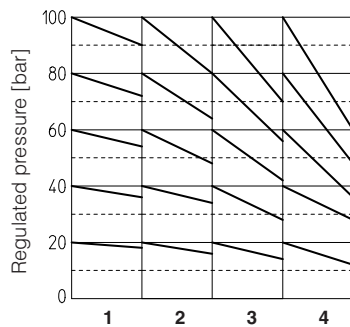

6 ELECTRIC CONNECTORS ACCORDING TO DIN 43650 FOR AGIU WITH SOLENOID VALVE

The connectors must be ordered separately

Code of connector	Function
666	Connector IP-65, suitable for direct connection to electric supply source
667	As 666 connector IP-65 but with built-in signal led, suitable for direct connection to electric supply source

For other available connectors, see tab. E010 and K500

7 ELECTRIC FEATURES FOR AGAM WITH SOLENOID VALVE

Solenoid valve type	External supply nominal voltage ± 10% (1)		Voltage code	Type of connector	Power consumption (3)		Code of spare coil DHI	Colour of coil label DHI	Code of spare coil DHE
					DHI	DHE			
DHI DHE	DC	12 DC 24 DC 110 DC 220 DC	12 DC 24 DC 110 DC 220 DC	666 or 667	33 W	30 W	COU-12DC COU-24DC COU-110DC COU-220DC	green red black black	COE-12DC COE-24DC COE-110DC COE-220DC
		AC	110/50 AC (2) 115/60 AC 120/60 AC 230/50 AC (2) 230/60 AC	110/50/60 AC 115/60 AC (5) 120/60 AC (6) 230/50/60 AC 230/60 AC	666 or 667	60 VA - 60 VA 60 VA 60 VA	58 VA 80 VA - 58 VA 80 VA	COI-110/50/60AC - COI-120/60AC COI-230/50/60AC COI-230/60AC	yellow - white light blue silver

(1) For other supply voltages available on request see technical tables E010, E015.

(2) Coil can be supplied also with 60 Hz of voltage frequency: in this case the performances are reduced by 10 ÷ 15% and the power consumption is 55 VA (DHI) and 58 VA

(3) Average values based on tests performed at nominal hydraulic condition and ambient/coil temperature of 20°C.

(4) When solenoid is energized, the inrush current is approx 3 times the holding current.

(5) Only for DHE

(6) Only for DHI

8 DIMENSIONS [mm]

AGIR, AGIS, AGIU size 10

ISO 5781: 2000

Mounting surface: 5781-06-07-0-00

Fastening bolts:

4 socket head screws M10x45 class 12.9

Tightening torque = 70 Nm

Seals: 2 OR 109/70, 2 OR 3068

Ports A, B: Ø = 14 mm

Ports X, Y: Ø = 5 mm

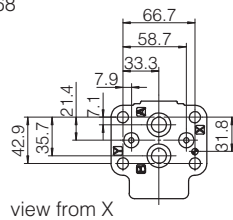

view from X

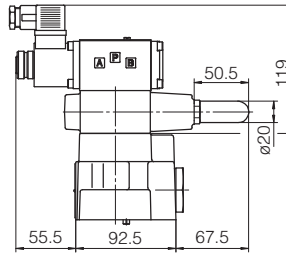

AGIU-10/10/-IX**
Mass = 5,3 Kg

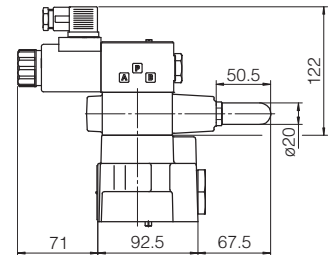

AGIU-10/10/-EX**
Mass = 5,6 Kg

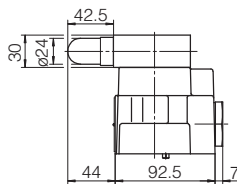

AGIR-10; Mass= 3,3 Kg
AGIRR-10; Mass= 3,5 Kg

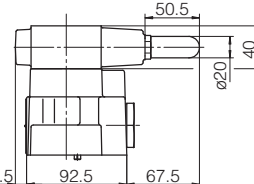
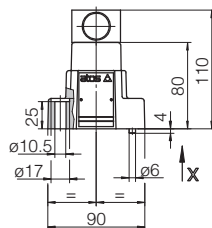

AGIS-10; Mass= 3,8 Kg
AGIU-10; Mass= 3,8 Kg

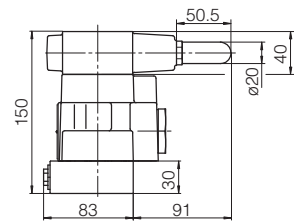

AGISR-10; Mass= 5,3 Kg

AGIR, AGIS, AGIU size 20

ISO 5781: 2000

Mounting surface: 5781-08-10-0-00

Fastening bolts:

4 socket head screws M10x45 class 12.9

Tightening torque = 70 Nm

Seals: 2 OR 109/70, 2 OR 4100

Ports A, B: Ø = 22 mm

Ports X, Y: Ø = 5 mm

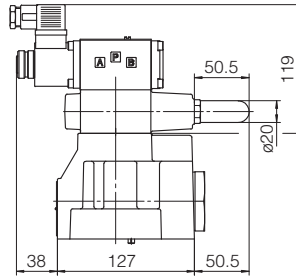
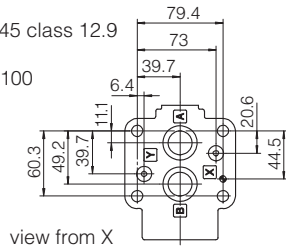

AGIU-20/10/-IX**
Mass = 7,5 Kg

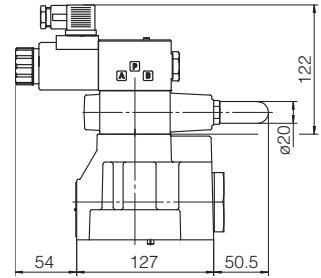

AGIU-20/10/-EX**
Mass = 7,8 Kg

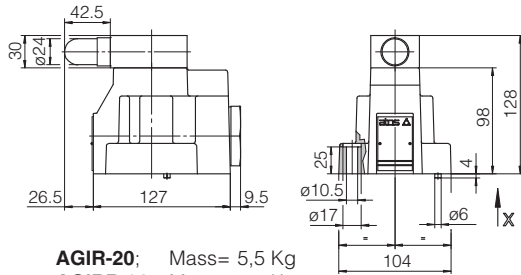

AGIR-20; Mass= 5,5 Kg
AGIRR-20; Mass= 5,7 Kg

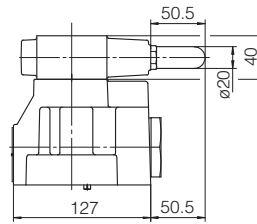

AGIS-20; Mass= 6 Kg
AGIU-20; Mass= 6 Kg

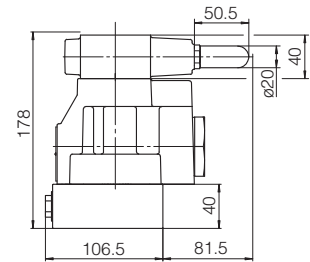

AGISR-20; Mass= 9 Kg

AGIR, AGIS, AGIU size 32

ISO 5781: 2000

Mounting surface: 5781-10-13-0-00

Fastening bolts:

6 socket head screws M10x45 class 12.9

Tightening torque = 70 Nm

Seals: 2 OR 109/70, 2 OR 4131

Ports A, B: Ø = 28 mm

Ports X, Y: Ø = 5 mm

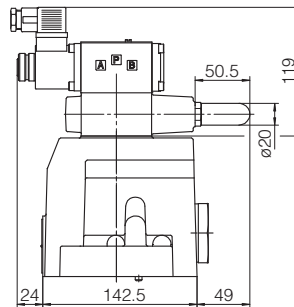
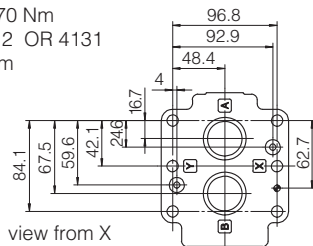

AGIU-32/10/-IX**
Mass = 11,4 Kg

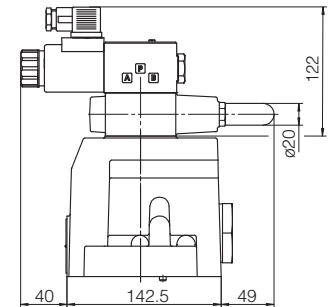

AGIU-32/10/-EX**
Mass = 11,7 Kg

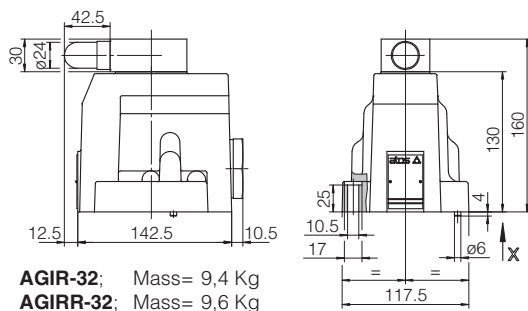

AGIR-32; Mass= 9,4 Kg
AGIRR-32; Mass= 9,6 Kg

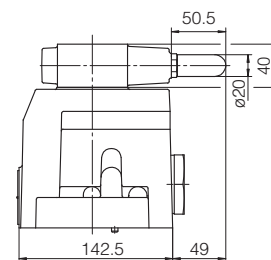

AGIS-32; Mass= 9,9 Kg
AGIU-32; Mass= 9,9 Kg

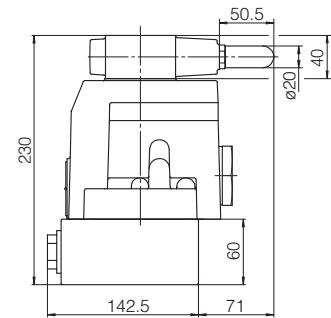

AGISR-32; Mass= 15.5 Kg

Overall dimensions refer to valves with connectors type 666

9 MOUNTING SUBPLATES

Valves	Subplate model	Port location	Ports				Ø Counterbore [mm]				Mass [Kg]
			A	B	X-Y	OUT	A	B	X-Y	OUT	
AGI*-10	BA-305	Ports A, B, Y underneath;	G 1/2"	G 1/2"	G 1/4"	-	30	30	21,5	-	1
AGI*-20	BA-505		G 1"	G 1"	G 1/4"	-	46	46	21,5	-	2
AGI*-32	BA-705		G 1 1/2"	G 1 1/2"	G 1/4"	-	63,5	63,5	21,5	-	7,5
AGIU-10	BA-325 (with incorporated check valve)	G 1/2"	G 3/4"	G 1/4"	G 1/2"	30	36,5	21,5	30	5	
AGIU-20	BA-425 (with incorporated check valve)	Ports A, B, Y underneath;	G 1"	G 1"	G 1/4"	G 1"	46	46	21,5	46	6,5
AGIU-32	BA-625 (with incorporated check valve)		G 1 1/2"	G 1 1/2"	G 1/4"	G 1 1/2"	63,5	63,5	21,5	63,5	13

The subplates are supplied with fastening bolts. For further details see table K280